

# Sonic Meter <sup>®</sup>

# *Sonic A0*

## Operating Manual

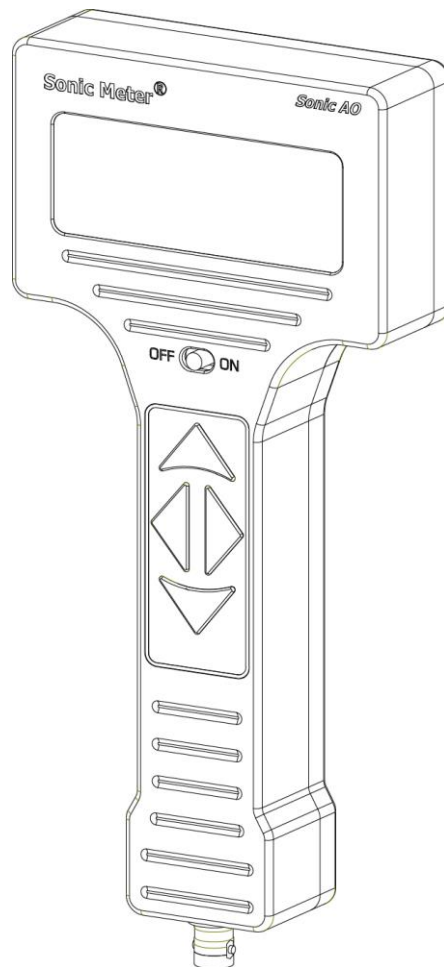

Important: Do not attempt to operate this instrument without completely reading this manual and understanding the correct operating procedures.

For online technical support and further information refer to our web site at **[www.sonicmeter.com](http://www.sonicmeter.com)**

# Table of Contents

1. Safety
  - 1.1 Batteries
  - 1.2 Charger
  - 1.3 Meter
  - 1.4 Probe
  - 1.5 Electromagnetic Compatibility
  
2. Introduction
  
3. Description
  - 3.1 Sonic Meter
  - 3.2 Keypad
  - 3.3 LCD display
  - 3.4 1 meter cable
  - 3.5 Sonic Meter probe
  - 3.6 Battery Charger
  - 3.7 Batteries
  
4. Operation
  - 4.1 Changing the batteries
  - 4.2 Resetting the circuit breaker
  - 4.3 Powering up the meter
  - 4.4 Options
  - 4.5 Battery capacity
  - 4.6 Real time reading
  - 4.7 Averaged reading
  - 4.8 Setup
  - 4.9 Powering off the meter
  - 4.10 How to take measurements
  
5. Appendices
  - A. Specifications
  - B. Troubleshooting
  - C. Parts List
  - D. Warranty
  - E. Calibration sheet

# 1. Safety Issues:

## 1.1 Batteries:

The **Sonic Meter *Sonic AO*** is powered by 4 AAA Nickel Metal Hydride (NiMH) batteries rated at 1000mAh. The meter is fault protected against reverse polarity via a resettable circuit breaker. The meter ships with 8 AAA batteries. The 4 AAA batteries in the meter were charged at the time of shipping. The other 4 AAA batteries are not charged.

**CAUTION: Shorting the batteries (positive terminal connected to negative terminal) is extremely dangerous and could cause serious injury. Extreme caution should be used when handling and charging the batteries.**

Do not store meter for long periods with the batteries installed. When disposing of batteries follow all state and local laws.

## 1.2 Charger:

The battery charger is powered by 120/240Volts AC at 50/60Hz. Use of charger with any other voltage input will damage the charger and could cause serious injury.

## 1.3 Meter:

The **Sonic Meter**'s housing is *not* waterproof. If the meter becomes immersed in water do not attempt to use it. Do not attempt to repair it. Return the meter to SyncroCraft® for authorized repair.

## 1.4 Probe:

The probe attaches to one end of the 1 meter co-axial BNC cable. The other end of the BNC cable connects to the meter. **Never attempt to remove or install the probe or cable while the meter is powered. Attempting this could cause voltage surges, possibly damaging the probe or meter.**

## 1.5 Electromagnetic Compatibility:

The **Sonic Meter *Sonic AO*** complies with EN 61326-1:1997. The meter is CE approved.

**Important:** The **Sonic Meter *Sonic AO*** is not designed for use as a medical device.

**Important:** Never operate the **Sonic Meter *Sonic AO*** and probe in areas where high voltage potentials are not properly contained.

**NOTE:** Please read and understand the entire manual before operating the **Sonic Meter *Sonic AO***.

## 2. Introduction:

The **Sonic Meter *Sonic AO*** is a *pressure sensitive* measuring device. It is designed to help maintain the quality and integrity of parts during cleaning cycles in ultrasonic cleaners.

Ultrasonic cleaners utilize a transducer attached to the tank's exterior. The transducer outputs pulsating mechanical energy at high frequencies (ultrasonic), which cause the liquid in the tank to agitate.

The agitation at this high frequency level is what gives ultrasonic cleaners their cleaning ability. As the liquid becomes agitated, a phenomenon known as cavitation takes place. Cavitation is the almost instantaneous formation and implosion of small bubbles and cavities in the cleaning liquid.

As the liquid cavitates, the minute bubbles and the coincidental implosions cause the surrounding liquid to impinge forcefully upon the surface areas of the part being cleaned. The force that the liquid applies to the area of the part is commonly referred to as the *scrub-force*.

This scrub-force action takes place throughout the tank. However, the scrub-force can vary significantly due to the placement of the tank's transducer and the constructive and destructive interference caused by the shape of the tank and parts being cleaned.

These process variations in scrub-force throughout the tank can be referred to as hot spots or cold spots in the liquid. Hot and cold spots are locations of high and low intensity scrub-force relative to a mean value scrub-force. These process variations can significantly alter the cleanliness or integrity of the parts being cleaned. Some parts may not have been thoroughly cleaned for the next process, or the stresses due to the cleaning action may have altered the integrity of the parts. With the **Sonic Meter** these process variation situations can be minimized.

With the **Sonic Meter**'s slender probe, operators can probe ultrasonic cleaners to pinpoint areas of optimum intensity in which to place each part. The **Sonic Meter**'s LCD displays the intensity variations. Parts can be varied in their z-height or their x and y positions via an adjustable array fixture. The operator can determine the location for each part so that all parts are placed in regions of the same specified *pressure* reading (scrub-force). Alternately, several readings can be taken and averaged to determine the mean value pressure of a particular cleaner.

The **Sonic Meter *Sonic AO*** measures pressure in units of  $10^4$  Pascal (e4Pa). The ***Sonic AO*** works with tanks that use frequencies up to 500kHz.

### 3. Description:

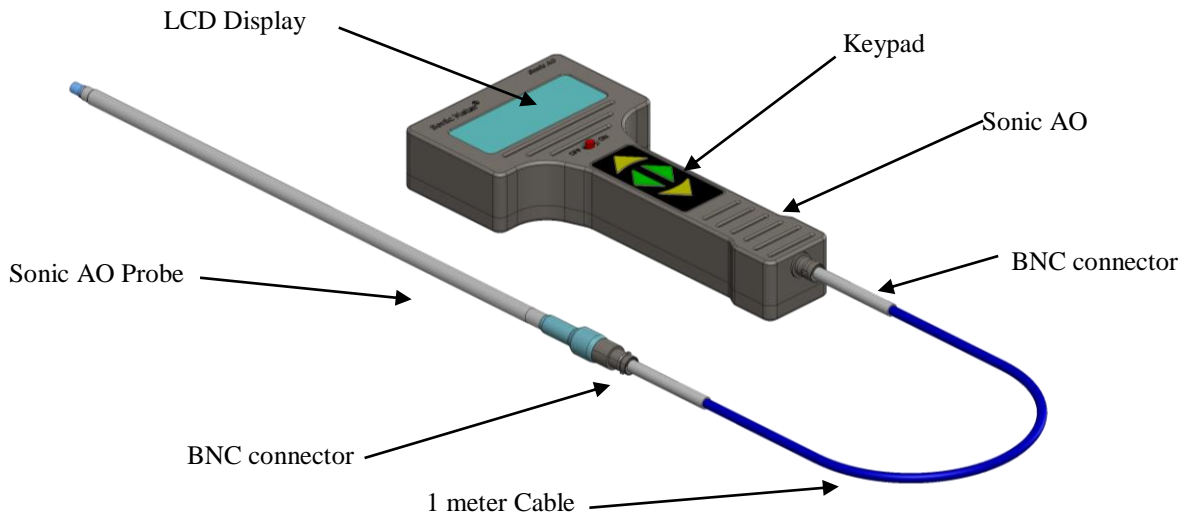

Figure 1

Figure 1 shows the main components of the **Sonic Meter *Sonic AO***.

#### 3.1 Sonic Meter:

The **Sonic Meter *Sonic AO*** is packaged in an ergonomic T-shaped housing. The housing is made of aluminum with a durable anodized surface. The housing is not waterproof.

### 3.2 Keypad:

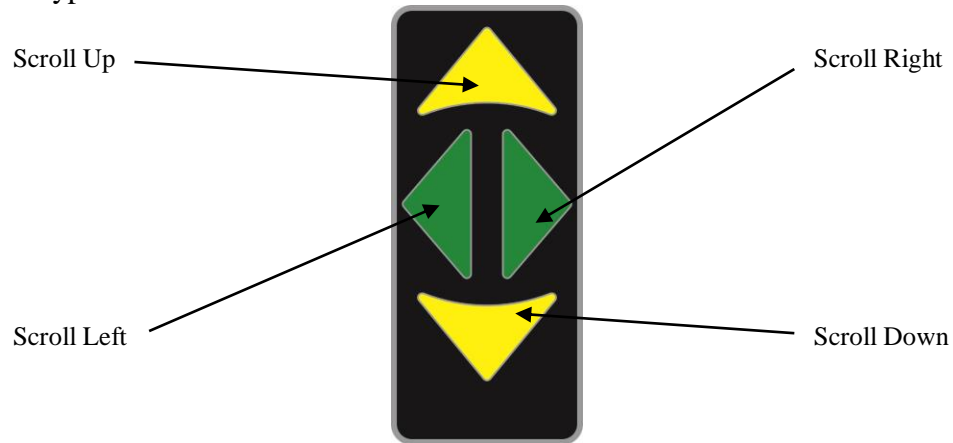

Figure 2

Figure 2 shows the designations of the keypad's four keys.

The keypad utilizes membrane keys with a color Mylar overlay. There are four keys that control the meter:

**Scroll Up:** Color designation is yellow. Used for scrolling up through the menu choices and increasing input values.

**Scroll Down:** Color designation is yellow. Used for scrolling down through the menu choices and decreasing input values.

**Scroll Right:** Color designation is green. Used for selecting a specific menu choice and for scrolling right when changing input values.

**Scroll Left:** Color designation is green. Used for returning back to the previous menu and for scrolling left when changing input values. **By holding this key the meter will always return to the main Options menu from any other menu.**

### 3.3 LCD Display:

The LCD is a character based, high contrast display made up of 4 lines by 20 characters. Information is displayed in a menu driven format where selections are made by scrolling to the desired selection point with the keypad.

### 3.4 1 meter cable:

The 1m BNC cable connects the meter to the probe.

**Never attempt to remove or install the probe or cable while the meter is powered on. Surges in voltage could damage the probe or meter.**

### 3.5 Sonic Meter Probe:

The probe is made of 304 stainless steel with a BNC connector at the top of the probe and the sensing transducer at the bottom. Each probe has a unique *sensitivity* value associated with the sensing transducer. The *sensitivity* value is input into the meter's memory via the keypad. The top of the probe is engraved with a serial number that distinguishes it from other **Sonic Meter** probes. If an operator were to switch the probe from the meter with another probe, the operator would need to power off the meter, switch the probes, power up the meter and then go into the Setup menu and change the probe's *sensitivity*. This procedure is explained in detail in section 4.8.

### 3.6 Battery charger:

The battery charger can only be used to charge Nickel Metal Hydride (NiMH) type rechargeable batteries. **Do not charge NiCd batteries or mix other batteries with NiMH batteries.**

The battery charger should only be powered by 120/240Volts AC at 50/60Hz. The plug type is NEMA 5-15.

### 3.7 Batteries:

The **Sonic Meter *Sonic AO*** ships with 8 AAA Nickel Metal Hydride (NiMH) batteries. The meter uses 4 AAA NiMH batteries rated 1.2V/800mAh or higher. The batteries should reach full charge in 5hrs or less.

**Do not attempt to charge these batteries with any other charger than the unit shipped with the meter.**



## 4. Operation:

### 4.1 Changing the Batteries

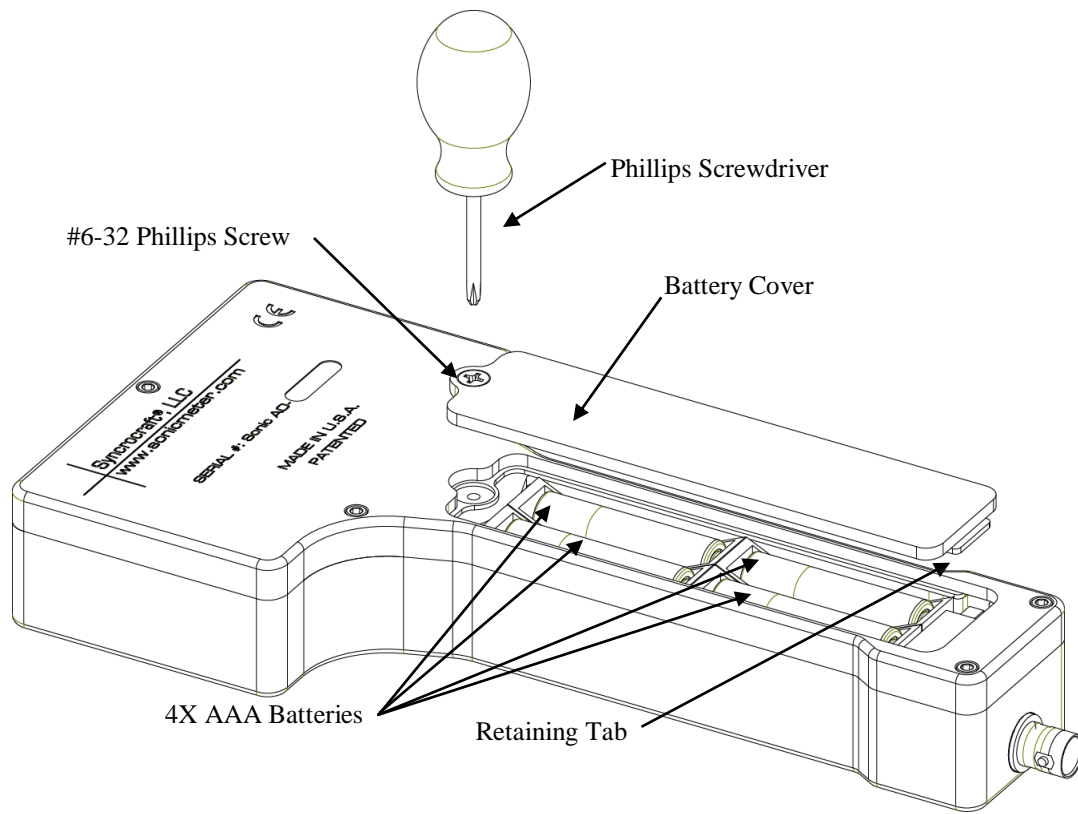

Figure 3

Figure 3 shows how the 4 AAA batteries are removed.

With a Phillips screwdriver, unscrew the 6-32 Phillips screw from the back of the meter. Lift the battery cover out from the meter. Remove the 4 AAA NiMH batteries, and replace with 4 charged batteries. Make certain that you replace the batteries into their sockets with the correct polarity. The polarity is clearly marked on the bottom of each battery socket. Reinstall the battery cover with the retaining tab positioned first in the bottom of the meter before securing the cover.

If the batteries are installed with the incorrect polarity, one of three situations will be evident:

1. One of the 4 batteries was installed with the incorrect polarity.

Observation: The meter will power on, but the battery percentage will not be displayed, and keypad keys will not function. Reinstall the battery correctly.

2. Two or three batteries were installed with the incorrect polarity.

Observation: The meter will not power on. Reinstall the batteries correctly.

3. All four batteries were installed with the incorrect polarity.

Observation: The 0.63Amp circuit breaker will disengage power. The meter will not power on. Remove all four batteries. Reset the circuit breaker. Reinstall the batteries correctly.

#### 4.2 Resetting the circuit breaker

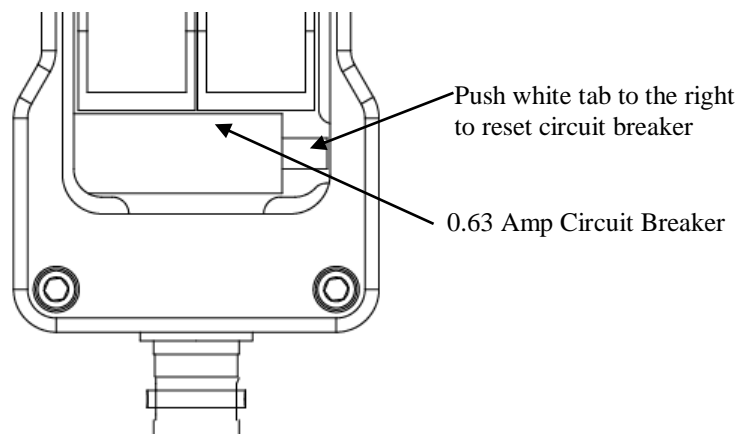

Figure 4

Figure 4 shows the circuit breaker located at the bottom of the meter just below the battery housing.

Remove the battery cover. With a small thin screwdriver, carefully push the small white tab of the circuit breaker to the right. A small click will sound when the reset tab has been moved all the way to the right. The circuit breaker is now reset.

The most probable reason for setting off the circuit breaker would be incorrectly installed batteries.

#### 4.3 Powering up the meter

Options: Batt. = 100%  
→ 1. Real time reading  
2. Averaged reading  
3. Setup

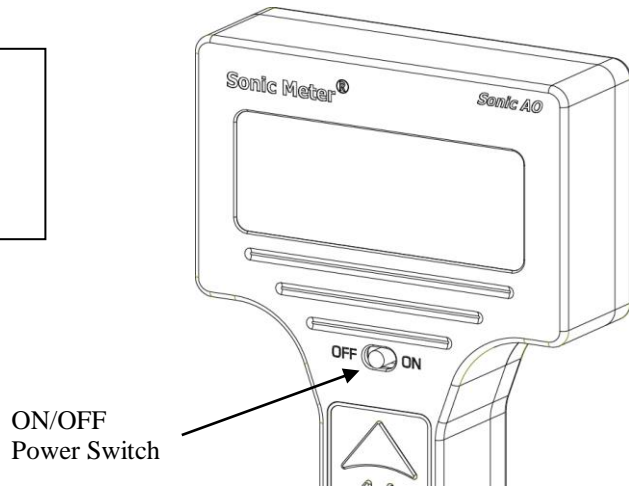

Figure 5

To power the meter on, move the Power Switch to the right as shown in Figure 5.

**Note: Before taking measurements, wait approximately 1 minute after powering up the meter. Waiting 1 minute allows the probe to come to full charge.**

#### 4.4 Options menu (main menu)

The Options menu will appear on the LCD after powering up the meter as shown in the upper left of Figure 5. The Options menu displays the battery capacity and three option selections: 1. Real time reading; 2. Averaged reading; and 3. Setup.

#### 4.5 Battery capacity

The battery capacity is displayed in percent. As the battery decreases in *voltage*, this value decreases. For NiMH batteries, this value will gradually drop until about 40%. After this point, the NiMH batteries drop off quickly. With continuous use, the meter will run approximately 5 hours.

#### 4.6 Real time reading

In Figure 5, the Options menu displays the *selection arrow* at the 1<sup>st</sup> position. Note: the 1<sup>st</sup> position (Real time reading) is always the default position of the *selection arrow* when entering the Options menu.

With the *selection arrow* still at the 1<sup>st</sup> position, press and release the Right Scroll key as shown in Figure 6

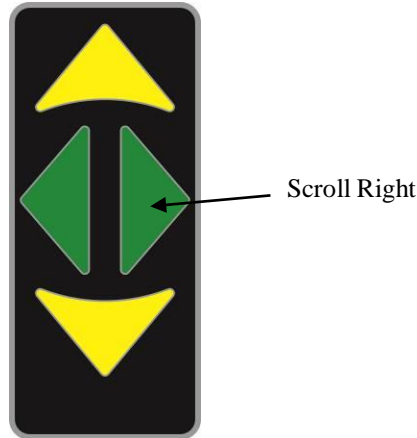

Figure 6

The following screen will appear on the LCD as shown below in Figure 7.

```
Pres. = ###.##e4Pa
Low < ###.##e4Pa
High > ###.##e4Pa
```

Figure 7

The real time pressure (e4Pa) is displayed along with the operator's specified Low and High range limits as shown above in Figure 7.

The Low and High range limits are input into the meter's non-volatile memory at the Setup stage, which will be explained in section 4.8 *Setup*.

The Low range limit indicator is a "<" symbol that is displayed in the upper left-hand corner. Refer to Figure 8. This indicator appears when the pressure reading is *less than* the acceptable Low range limit value XXX.XXe4Pa. At 0.00e4Pa this symbol is not displayed.

For example: If the Low range limit is < 15.00e4Pa and the actual pressure reading =14.99e4Pa, then the Low range limit indicator "<" will be displayed in the upper left-hand corner of the LCD as shown below in Figure 8.

```
< Pres. = 14.99e4Pa
Low < 15.00e4Pa
High > ###.##e4Pa
```

Figure 8

The High range limit indicator is a “>” symbol that is displayed in the upper right-hand corner. Refer to Figure 9. This indicator appears when the pressure reading is *more than* the acceptable High range limit value XXX.XXe4Pa.

For example: If the High range limit is > 25.00e4Pa and the actual pressure reading equals 25.01e4Pa, then the High range limit indicator “>” will be displayed in the upper right-hand corner of the LCD as shown below in Figure 9.

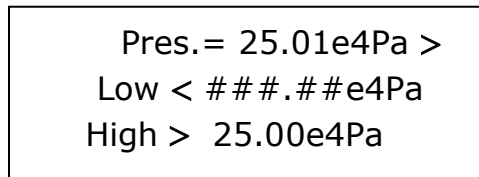

Figure 9

Return back to the Options menu at anytime by pressing and releasing the Left scroll key as shown below in Figure 10.

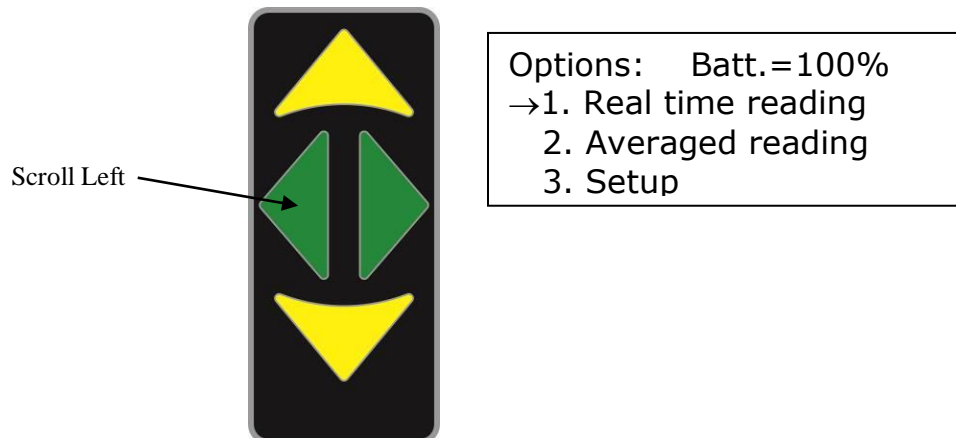

Figure 10

#### 4.7 Averaged readings

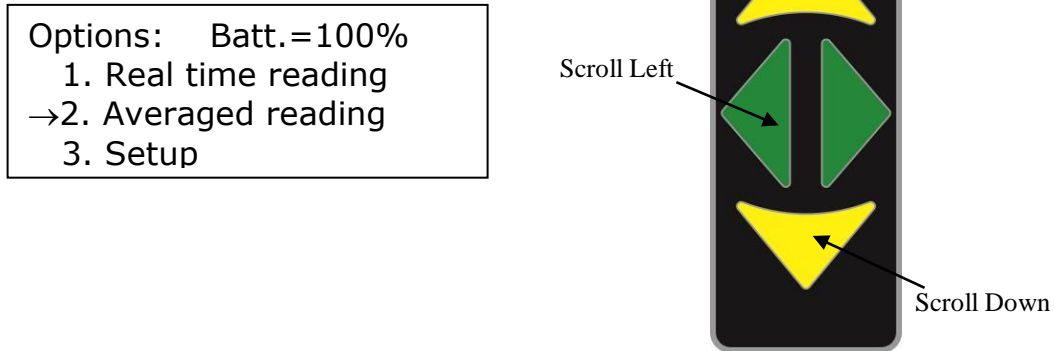

Figure 11

At the Option menu, scroll down to 2<sup>nd</sup> position as shown above in Figure 11. If the meter is not at the Option menu, press and hold the Scroll Left key.

With the *selection arrow* at the 2<sup>nd</sup> position, press and release the Scroll Right key to select the *Averaged reading* option. The following menu will appear as shown below in Figure 12.

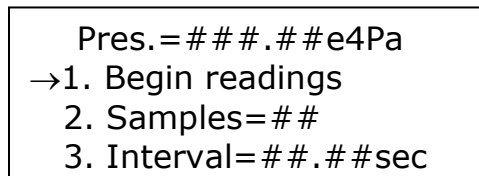

Figure 12

The first line displays the real time pressure. The real time pressure is displayed so that the operator can position the probe in the cleaner before taking an averaged reading. Below the real time pressure, the Averaged readings menu displays three selections: 1. Begin readings; 2. Samples= XX; and 3. Interval=XX.XXsec.

Selection 1 will initiate the averaging of the pressure based on the number of pressure reading samples and the time interval. Selection 2 will allow the user to select the number of samples. Selection 3 will allow the user to select the time interval per sample.

Before taking an average reading of the pressure, selections 2 and 3 will need to be setup.

Start by changing the Samples value. Press the yellow Scroll Down key once so that the selection arrow is on 2. If you passed selection 2, you can either press

the yellow Scroll Up key or keep pressing the Scroll Down key until the selection indicator is at selection 2 as shown below in Figure 13.

Pres.=###.##e4Pa 1. Begin readings →2. Samples=# <u>0</u> 3. Interval=##.##sec
---

Figure 13

With the selection indicator at the 2<sup>nd</sup> position, press and release the Scroll Right key. An underscored flashing cursor will appear in the ones digit of the Samples value as shown above in Figure 13.

**The number of samples can range from 0 to 40.**

With the cursor still in the ones digit, use the yellow Scroll Up or Scroll Down buttons to change this number. When the desired ones digit is set, press and release the Scroll Left key once. The underscored cursor will now be positioned in the tens digit as shown below in Figure 14. Once again, use the Scroll Up or Scroll Down keys to change this number.

Pres.=###.##e4Pa 1. Begin readings →2. Samples=# <u>10</u> 3. Interval=##.##sec
--

Figure 14

When the desired number is set for the tens digit, press and release the Scroll Left key once to return the selection arrow to the 2<sup>nd</sup> position. The value will automatically be saved in non-volatile memory.

To set the time interval between sampling, scroll down to the 3<sup>rd</sup> position with yellow Scroll Down key as shown below in Figure 15

Pres.=###.##e4Pa 1. Begin readings 2. Samples=10 →3. Interval=##.## <u>8</u> sec
---

Figure 15

With the selection indicator at the 3<sup>rd</sup> position, press and release the Scroll Right key. An underscored flashing cursor will appear in the hundredths digit of the Samples value as shown in above Figure 15.

**The time interval between samples can range from 0.01 to 99.99 seconds.**

```
Pres. = ###.##e4Pa
1. Begin readings
2. Samples = 10
→3. Interval = ##.28sec
```

Figure 16

With cursor still in the hundredths digit, use the yellow Scroll Up or Scroll Down buttons to change this number. When the desired hundredths digit is set, press and release the Scroll Left key once. The underscored cursor will now be positioned in the tenths digit as shown above in Figure 16. Once again, use the Scroll Up or Scroll Down keys to change this number. Repeat this step for the ones and tens digits. When the desired number is set for the ones and tens digits, press and release the Scroll Left key once to return to the selection arrow at the 3<sup>rd</sup> position. The value will automatically be saved in non-volatile memory.

When the number of samples and time interval parameters are set to the desired values, scroll up to the 1<sup>st</sup> position (Begin readings) by pressing and releasing the yellow Scroll Up key twice. To execute the averaging process, press and release the Scroll Right key once. The following screen prompt will appear as shown below in Figure 15. This screen will remain for the duration of the averaging. The index (number of samples) of the average will count down each of the readings and be displayed in the upper left-hand corner as shown below in Figure 17.

```
#
* Averaging Data *
```

Figure 17

After the averaging process has been completed, the following screen will display the average pressure value as shown in Figure 18.

```
Avg. = ###.##e4Pa
←exit
```

Figure 18



To return to the averaging screen press the Scroll Left key once. To return to the options screen, press the Scroll Left key again.

#### 4.8 Setup

From the Options menu, scroll down to the 3<sup>rd</sup> option as shown below in Figure 19.

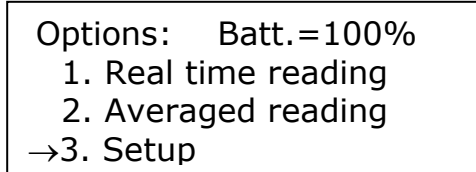

Options: Batt.=100%  
1. Real time reading  
2. Averaged reading  
→3. Setup

Figure 19

With the selection indicator at the 3<sup>rd</sup> position, press and release the Scroll Right key. The Setup menu will appear as shown below in Figure 20.

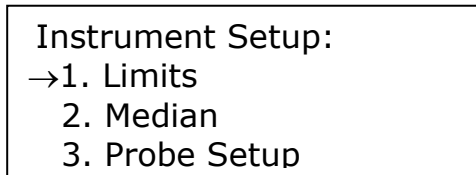

Instrument Setup:  
→1. Limits  
2. Median  
3. Probe Setup

Figure 20

Options 1 and 2 are used for setting up the low and high range limits that were explained in section 4.6. The low and high range limits are calculated as follows:

$$\begin{aligned}\text{low range} &= \text{median}(\text{value}) - \text{limits}(\text{value}) \\ \text{high range} &= \text{median}(\text{value}) + \text{limits}(\text{value})\end{aligned}$$

Example: median = 25, limits =  $\pm 5$ . The low and high range limits will be 20 and 30 e4Pa, respectively.

Now set the limits. With the selection indicator at the 1<sup>st</sup> position, press and release the Scroll Right key.

The following limits setup screen will appear as shown below in Figure 21.

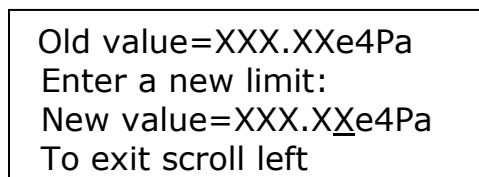

Old value=XXX.XXe4Pa  
Enter a new limit:  
New value=XXX.XXe4Pa  
To exit scroll left

Figure 21

The cursor will appear underscored and flashing in the hundredths position of the “New Value”. By using the yellow Scroll Up/Down keys, each digit can be changed. To move to the next digit use the Left Scroll key. The cursor can always be moved to the previous digit by using the Right Scroll key. After the last digit (hundreds) has been set, push the Left Scroll key once to return to the Setup menu. Values are automatically saved.

Now set the median. At the Setup menu, with the selection indicator at the 2<sup>nd</sup> position (Median), press and release the Scroll Right key.

The following median setup screen will appear as shown in below in Figure 22.

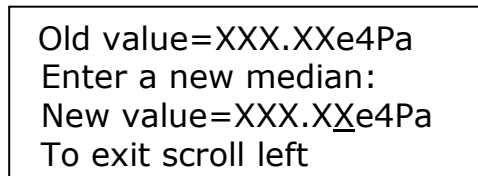

Old value=XXX.XXe4Pa  
Enter a new median:  
New value=XXX.XXe4Pa  
To exit scroll left

Figure 22

Use the same procedure to setup the median as was previously used for setting up the limits.

Now set the probe sensitivity.

*Each probe sold with each **Sonic Meter**<sup>®</sup> has a unique sensitivity value. Because of this, the probe sensitivity value will have to be changed whenever the probe is switched among meters or a probe has been replaced due to damage. If this is not done, the accuracy of the measured value will change by a small amount. The serial number of each probe is engraved at the top of the probe. The sensitivity and serial number for each probe is recorded in the Calibration Sheet (packaged with the meter). If more than two meters are used at the same location, occasionally check to make sure the probes are matched with their corresponding meters.*

At the Setup menu, with the selection indicator at the 3rd position (Probe), press and release the Scroll Right key.

The following median setup screen will appear as shown in below in Figure 23.

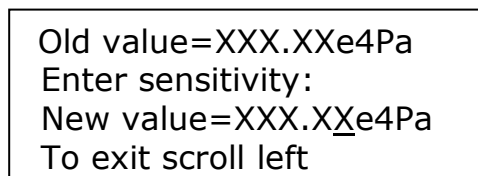

Old value=XXX.XXe4Pa  
Enter sensitivity:  
New value=XXX.XXe4Pa  
To exit scroll left

Figure 23

Use the same procedure to setup the probe sensitivity as was previously used for setting up the limits and median. Refer to Appendix E for the probe's sensitivity value.

#### 4.9 Powering off the meter

To power off the meter, simply move the ON/OFF switch to the left as shown in Figure 24.

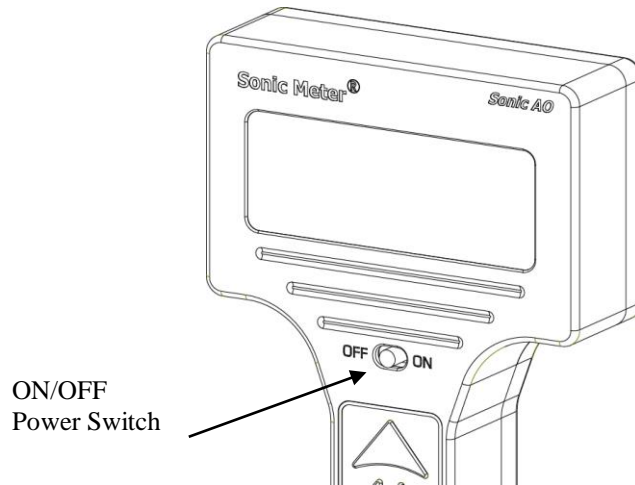

Figure 24

#### 4.10 How to take measurements

Follow the manufacturer's operating procedures before operating ultrasonic cleaners: set the proper degas and temperature settings before taking any readings.

##### **Quick real time pressure readings:**

The *real time reading* mode allows for a quick estimate of the pressure at a particular point. This is useful for checking pressure levels during the process of cleaning.

**Note: the pressure indicates the actual cleaning scrub-force at a particular location.**

Begin probing the tank with the meter in *real time reading* mode. Notice the fluctuations in the readings. The readings usually fluctuate  $\pm 3$  e4Pa for most tanks, but can fluctuate higher depending on your tank and the shape of the part sitting inside of it.

**Average pressure:**

For precise pressure readings, set the meter in *averaged reading* mode. Averaged reading mode is useful for determining the pressure levels of a particular point or the tanks overall output

For a good starting point, set the number of samples to 10, and the interval to 1 second. These settings will average 10 samples over a 10second period.

With the meter still in *averaged reading* mode, take 10 to 20 readings throughout the tank (more readings for larger tanks). Make sure to hold the probe steady while taking each average. Write down each reading. Then average these readings to get an overall pressure value for the tank.

Note: The more readings taken, the more accurate will be the overall average of the tank's output. If mapped at different depths, a clear picture of the distribution can be determined. Additional methods for increased repeatability involve readings at tightly held locations using some sort of grid plate located over the tank with locating holes. Also including multiple depths by using a lock collar along the body of the probe tube is very helpful.

**Factors that determine the tanks pressure output:**

Pressure levels can vary by as much as  $\pm 10e4\text{Pa}$  each time a different set of measurements is taken.

The factors that determine this variance are:

- Degas time
- Tank temperature
- Part geometry
- Probe position

*Degas* the tank according to the manufacturer's specifications. The degas time is usually 15-20 minutes.

Some tanks have a heat setting so that *temperature* can be controlled. Follow the manufacturer's specifications. Usually by the time the tank is degassed, the temperature has stabilized.

*Part geometry*: the shape of a part can cause a change in the pressure output. The part's shape can cause constructive and destructive interference.

*Probe position* is critical. Within only a few millimeters, the pressure can vary significantly (this variance differs by tank type). This is due to nodes of high and low pressure that develop within the liquid. For the highest level of precision, the probe should be held in some type of fixture that allows for x, y and z positions.

## 5. Appendices:

### A. Specifications

**Bandwidth:** up to 500kHz

**Pressure reading:** 0-150e4Pa, accuracy < 3% error. Determined over the entire working range.

**Temperature Operating Range:** -65 to 250 F or -55 to 120 C

**Performance:** Real time reading samples pressure every 50msec. Averaged reading can sample 0-40 readings at sample intervals of 10msec to 99.99sec.

**Accuracy:** The **Sonic Meter *Sonic AO*** uses a 12bit ADC to digitize the analog signal coming from the probe's transducer. The precision of the meter is  $\pm 0.03e4Pa$ .

**Battery life (hours):** The **Sonic Meter *Sonic AO*** consumes current at a rate 150mA/hour. The NiMH batteries are rated at 800 to 1000mAh. For continuous use, the meter will run approximately 5 hours before batteries will need to be recharged.

### B. Troubleshooting

Meter fails to power on:

1. Batteries need to be recharged.
2. Batteries were improperly installed. (refer to section 4.1)
3. Circuit breaker has tripped. (refer to section 4.1 and 4.2)
4. Circuit fault unknown (return to Authorized Dealer)

Meter fails to power off:

1. Circuit fault unknown (return to Authorized Dealer)

Pressure reads zero when tanks are on:

1. Cable has a line break.
  - \*measure impedance of cable: 1-5ohms acceptable
  - \*replace cable if impedance is above 5 ohms
2. Probe fault unknown (return to Authorized Dealer)
3. Meter fault unknown (return to Authorized Dealer)

### C. Parts list

1. Meter: # Sonic AO-meter
2. Probe: # Sonic AO-probe
3. Cable: # Sonic AO-cable
4. Case: # Sonic AO-case
5. Manual: # Sonic AO-manual
6. Battery charger: # Sonic AO-charger
7. Batteries: # Sonic AO-battery

### D. Warranty

The manufacturer, SyncroCraft<sup>®</sup>, LLC, warrants the **Sonic Meter *Sonic AO*** against defects in materials and workmanship for a period of 12 months from the date of shipment to the original purchaser. SyncroCraft<sup>®</sup>, LLC will, at its option, repair or replace products that prove to be defective.

The foregoing warranty shall not apply to defects resulting from improper use or modification.

No other warranty is expressed or implied. SyncroCraft<sup>®</sup>, LLC specifically disclaims warranties of merchantability and application for a particular purpose

E. Authorized Dealers

For Sales or Service in the United States, North and South America, or Europe contact:

**SyncroCraft<sup>®</sup>, LLC**

16225 Camino del Sol

Los Gatos, CA 95032

Tel: (408)438-0597

e-mail: [syncrocraft@comcast.net](mailto:syncrocraft@comcast.net)

URL: <http://www.sonicmeter.com>

For Sales or Service in Asia contact:

**Shinka Industry Co., Ltd.**

Asahi-tamagawa building 2F, 1-636 Maruko-dori, Nakahara-ku, Kawasaki,  
211-0006 Japan

Tel: +81-44-589-6367

Fax: +81-44-589-6368

e-mail: [sk@shinka-sangyo.co.jp](mailto:sk@shinka-sangyo.co.jp)

URL: <http://www.shinka-sangyo.co.jp>